

DANTEQ – PhD project work

Christoph Josef Backi

NTNU – Department of Engineering Cybernetics

SINTEF – Fisheries and Aquaculture

28 May 2014

Topics

Investigating the freezing process for fish in vertical plate freezers

- Mathematical modeling of heat transfer in the fish block
 - Partial differential equations modeling thermodynamic phenomena
 - Stability properties
- Applications (with focus on energy saving)
 - Freezing time prediction
 - Observer based techniques
 - Estimation of nonmeasurable, inner-domain temperatures
 - Optimal boundary control

Freezing system

Vapor-compression refrigeration process

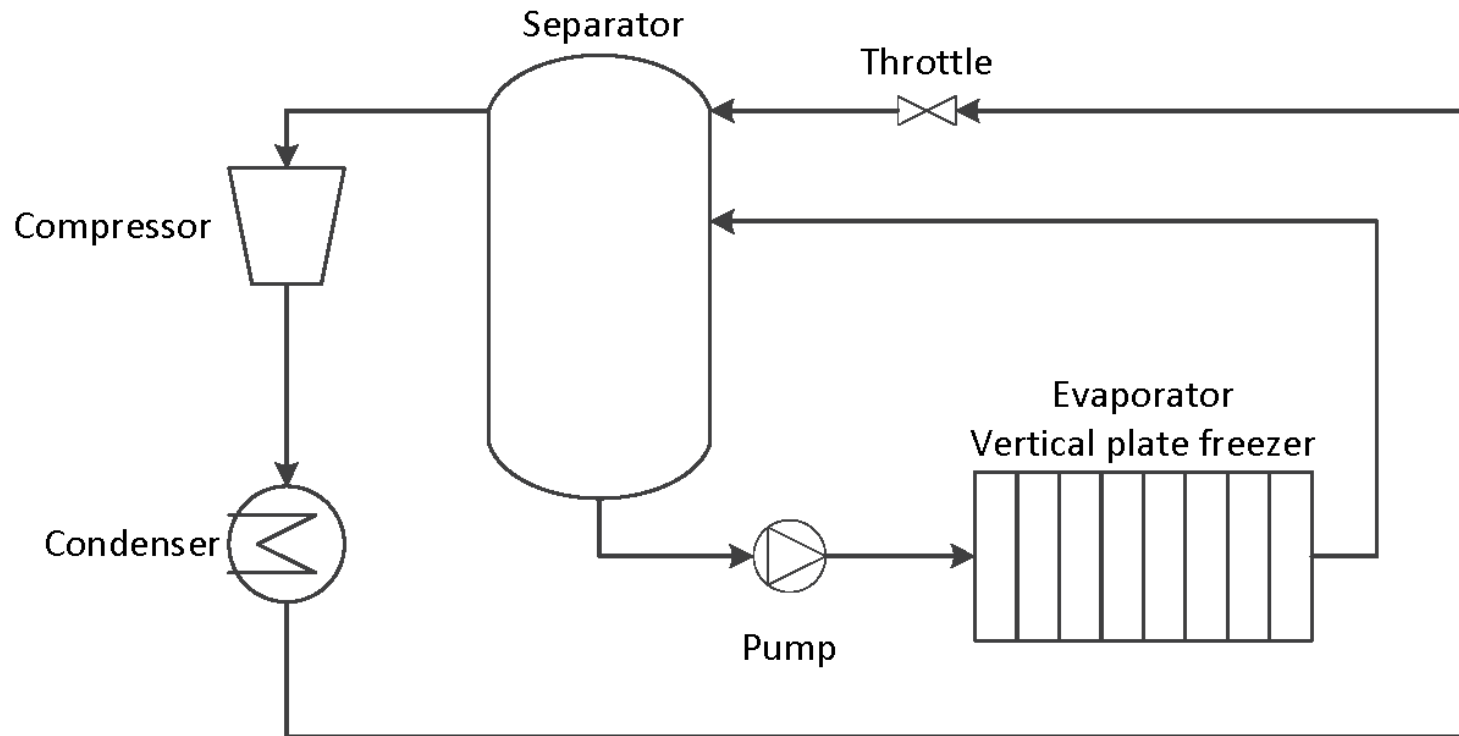

Freezing system

Vapor-compression refrigeration process

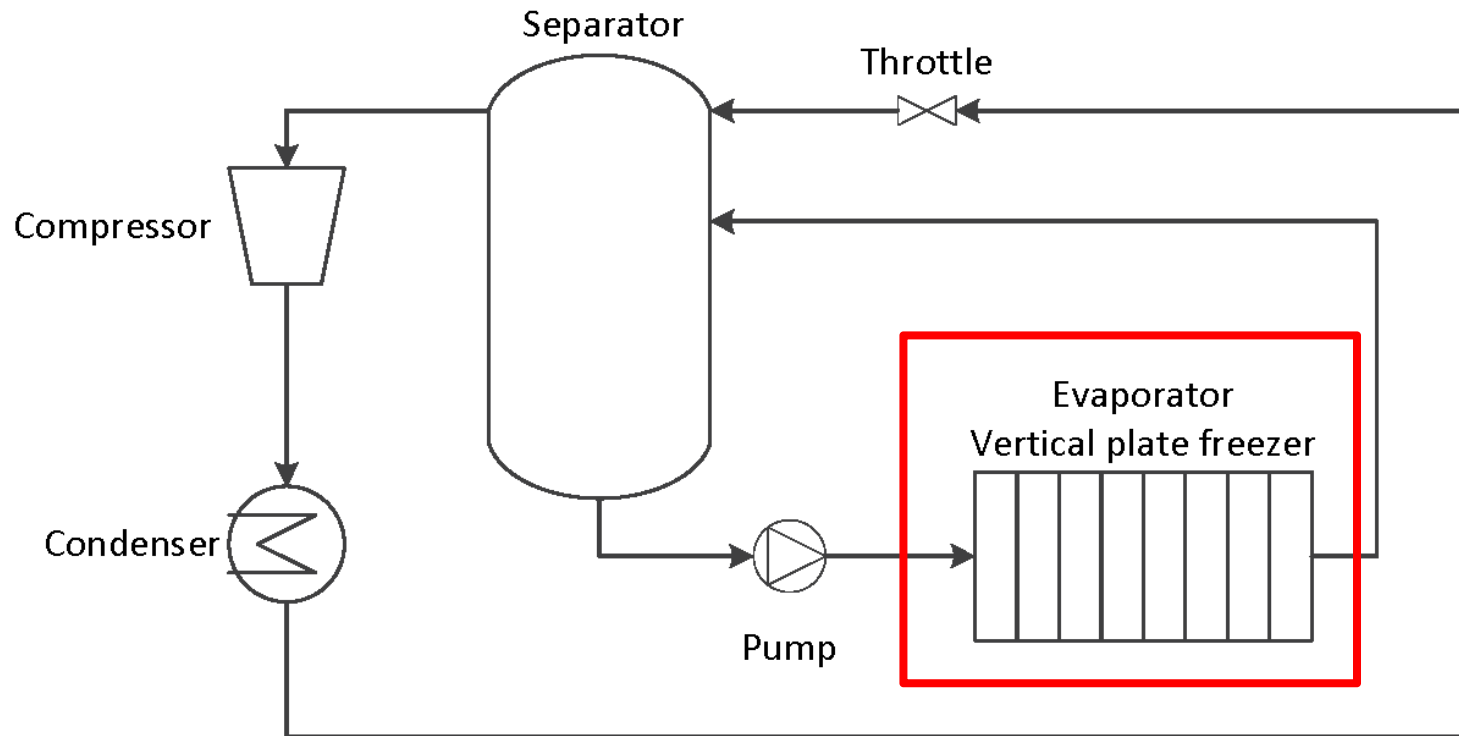

Freezing system

Vertical plate freezer → fish blocks

Modeling of the Temperature distribution throughout the fish block with a *Partial Differential Equation (PDE)*



Model – Partial Differential Equation

Describes the temperature distribution in the fish block in space and time

Actuation via the boundaries

Physical parameters change from species to species

Phase transition during freezing requires further adaptation of parameters
→ Temperature-dependent parameters

Model – Partial Differential Equation

One essential part: *Thermal arrest caused by latent heat of fusion*

Model – Partial Differential Equation

One essential part: *Thermal arrest caused by latent heat of fusion*

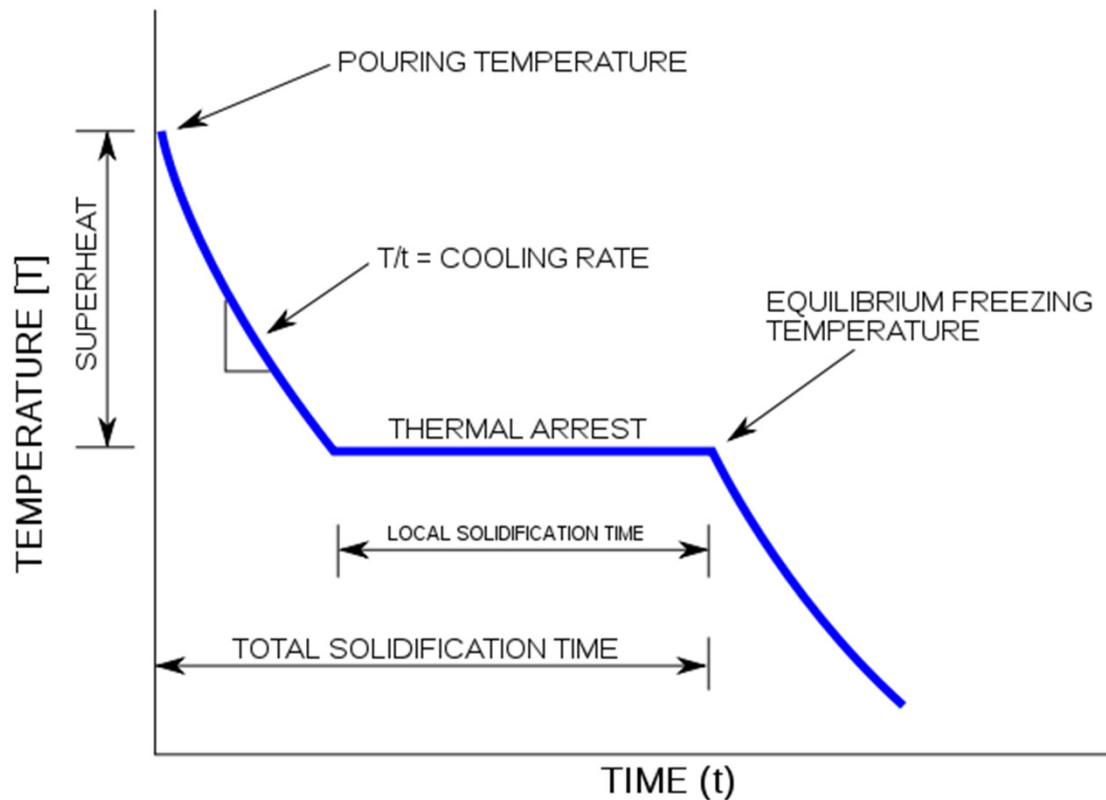

Model – Partial Differential Equation

Stability of the PDE

Freezing process *stable* in the sense of thermodynamic laws
→ Overall temperature will converge to the input temperature

But also: Theoretical study about *stability* of the model
→ Stability proven for a set of parameters

Model – Partial Differential Equation

Simulation example
1 dimension

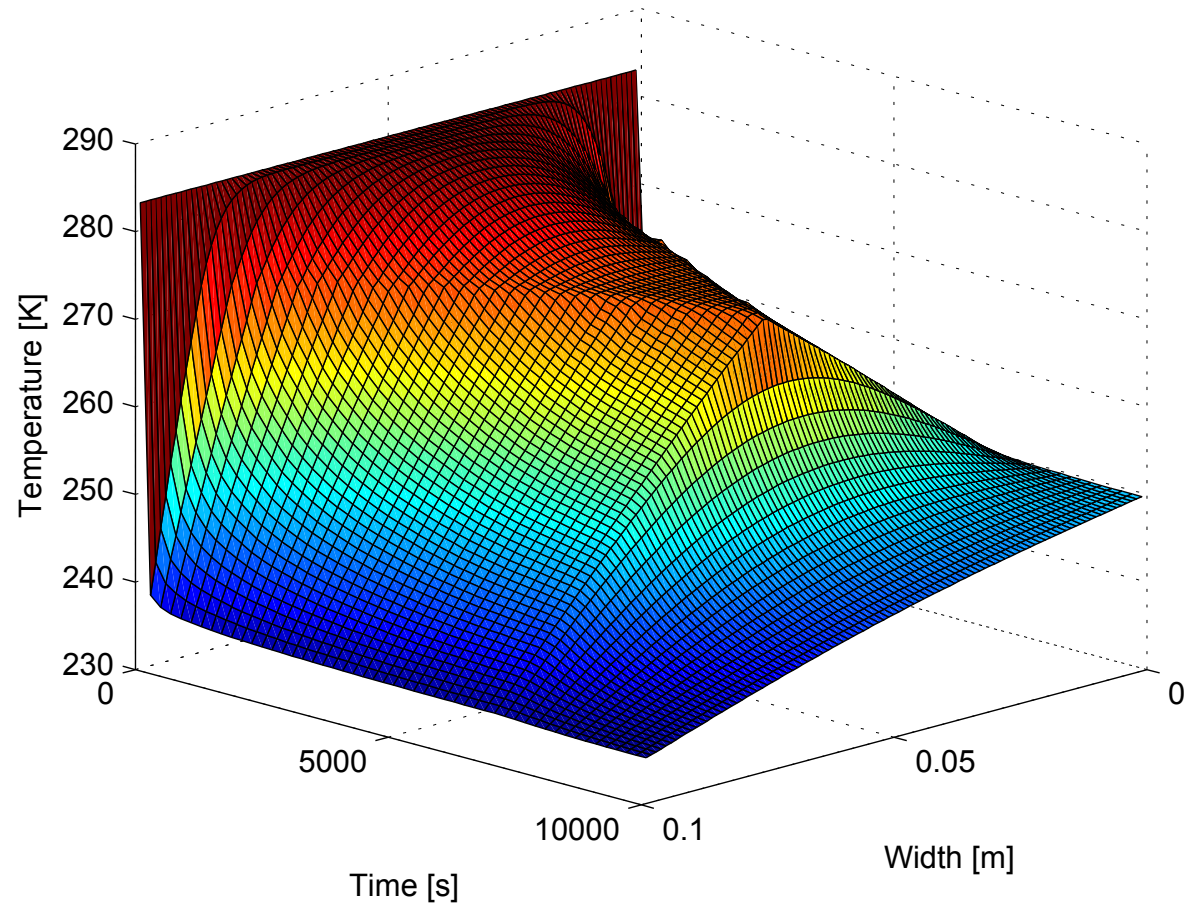
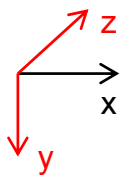
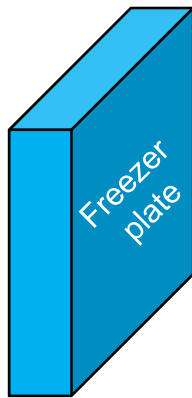

Model – Partial Differential Equation

Simulation example
2 dimensions

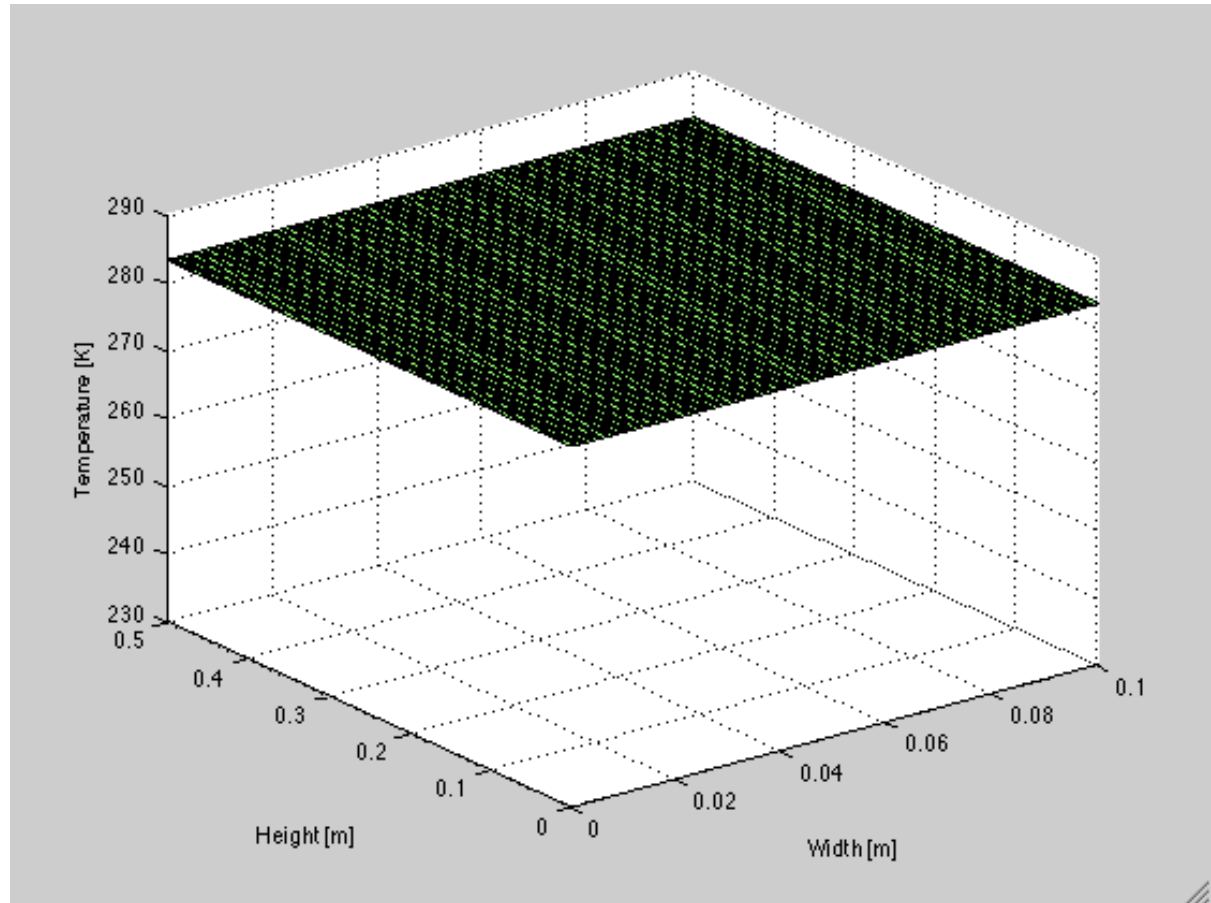
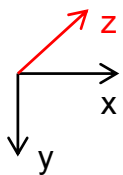
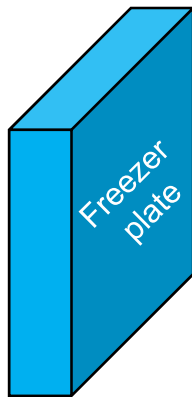

Model – Partial Differential Equation

Comparison

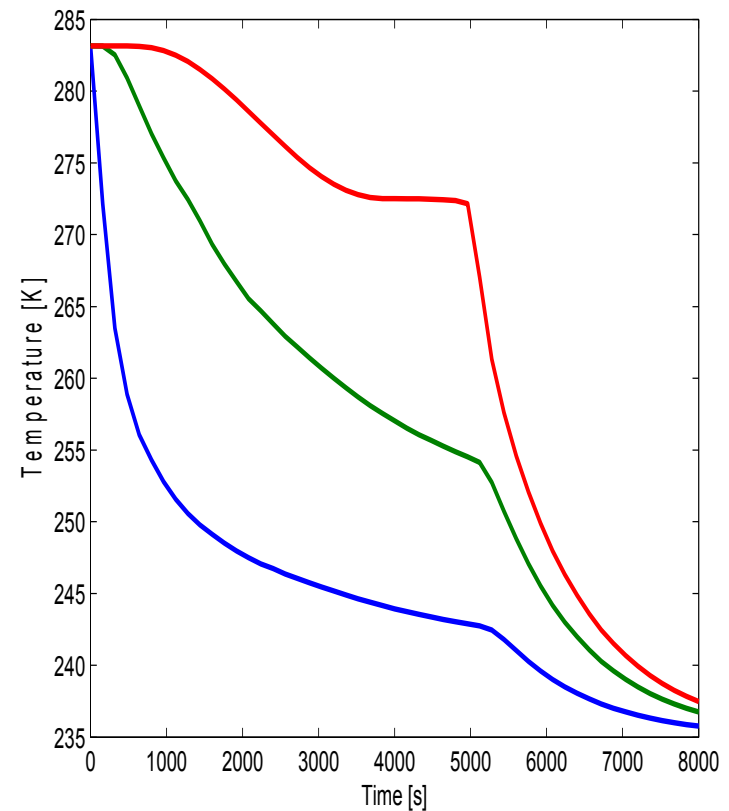
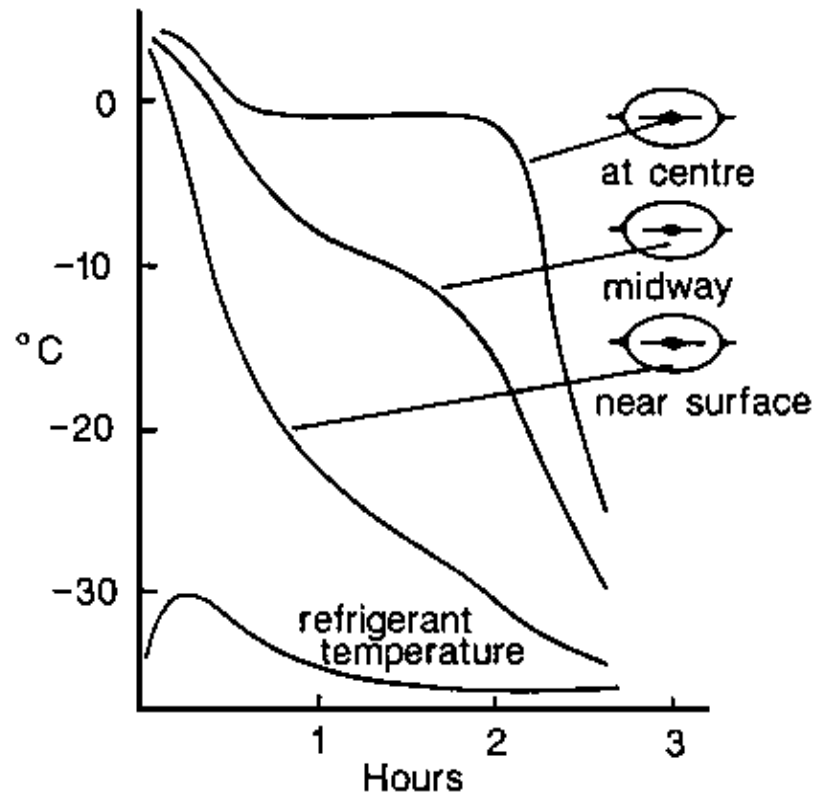

Applications

Necessary to discretize the spatial variable

→ Either 1 or 2 dimensions (width or width and height)

Assumption: Symmetric boundary conditions

→ Symmetric problem

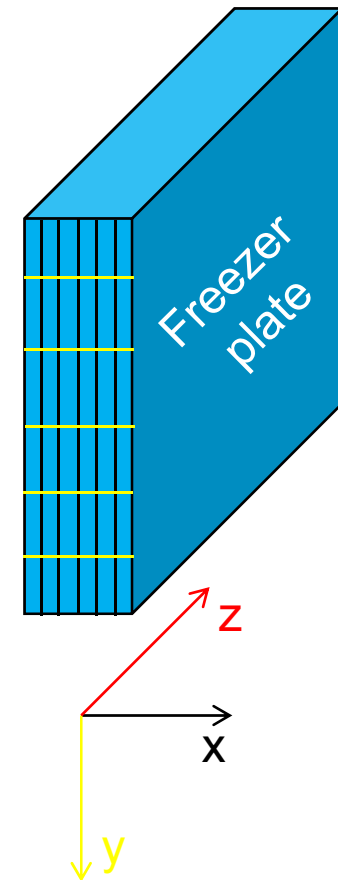

Applications – Estimation

Estimator for inner-domain temperatures based on measurements

2-dimensional model representing width and height of the fish block

→ Discretization: 45 states (9 in x-direction times 5 in y-direction)

Measurements of boundary states on the sides and on top

→ No inner-domain measurements

Applications – Estimation

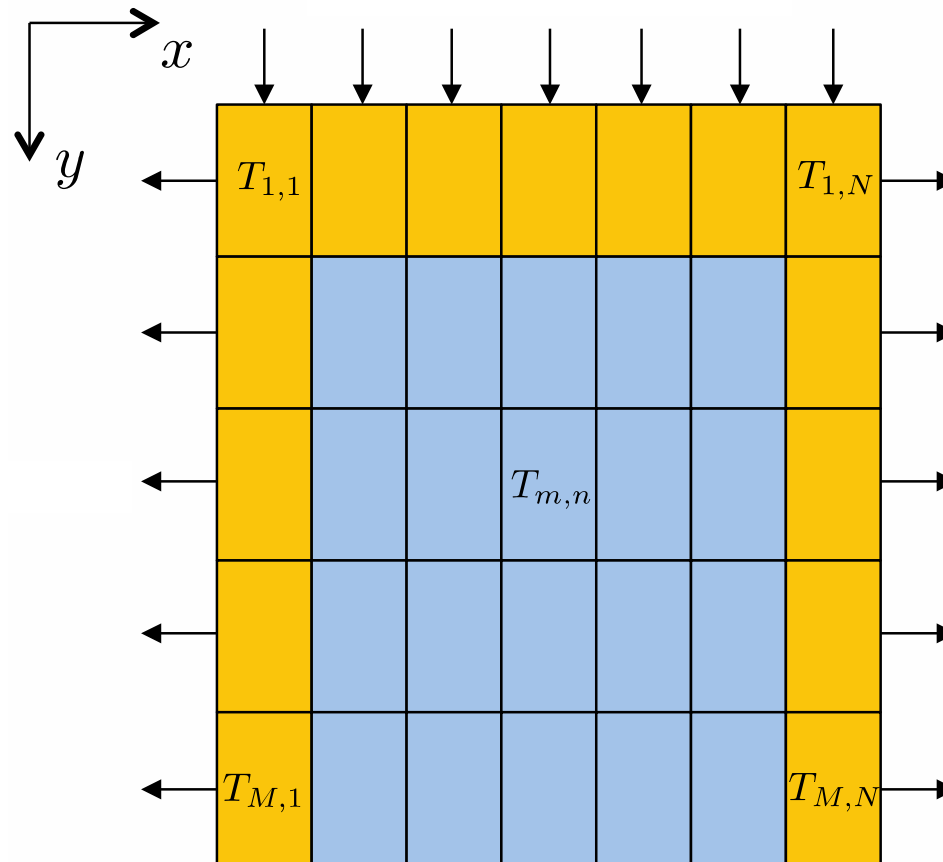

Applications – Estimation

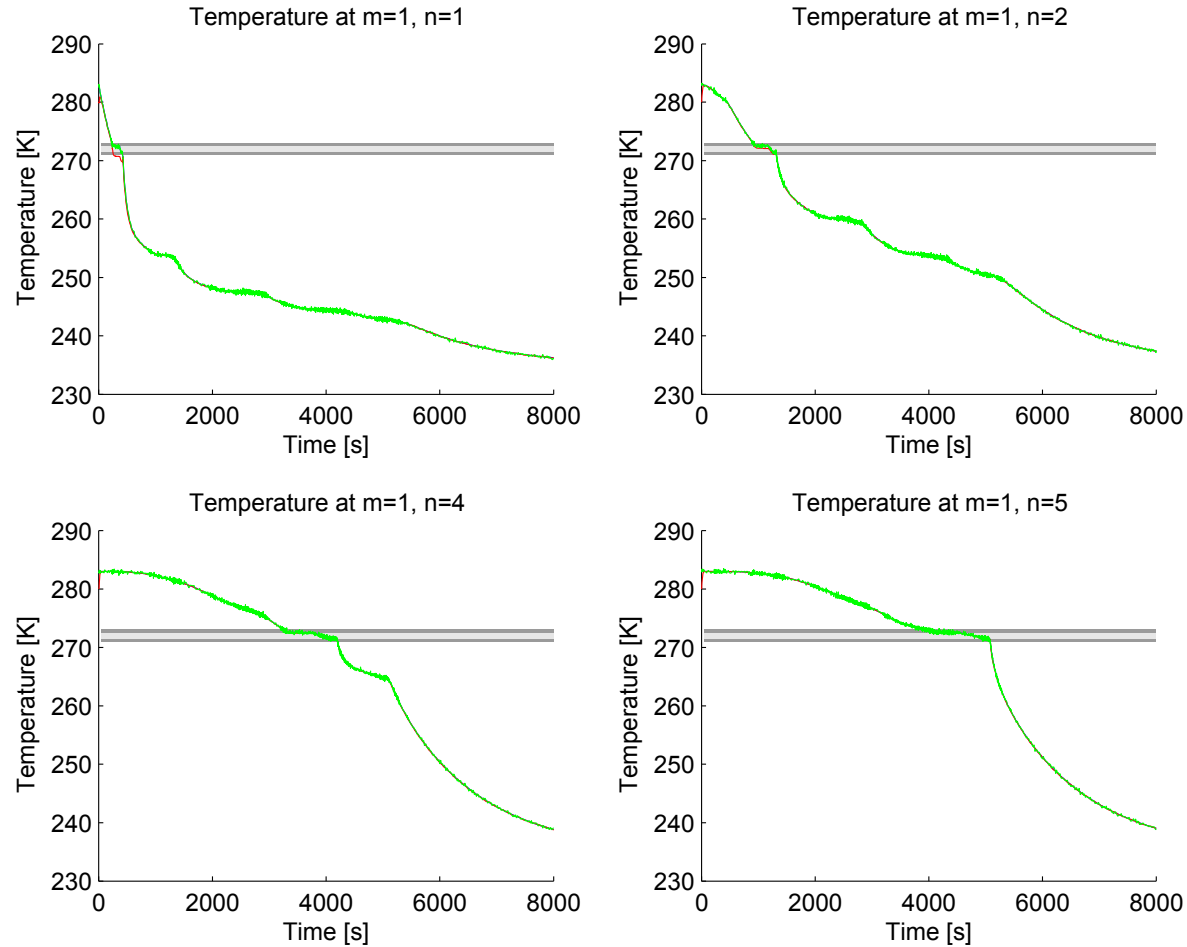

Applications – Estimation

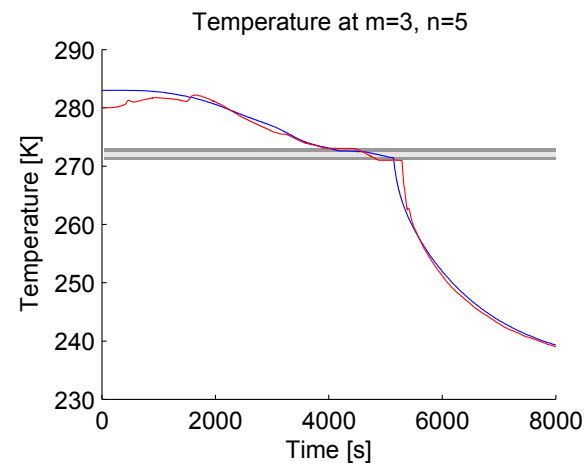
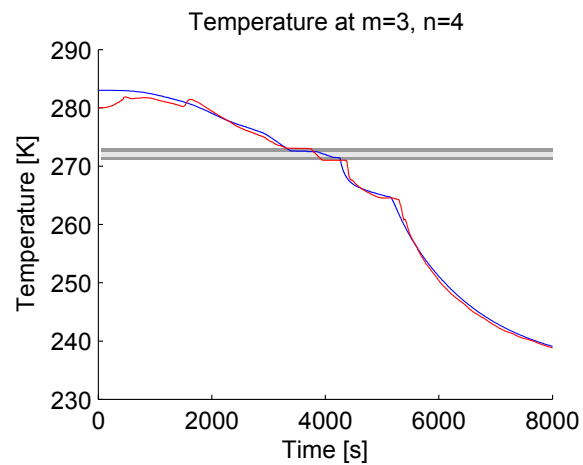
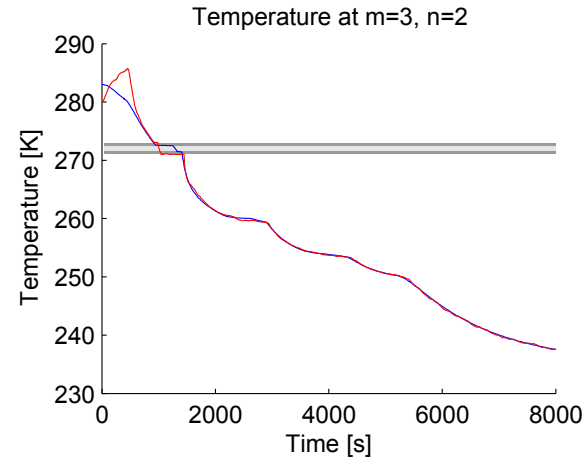
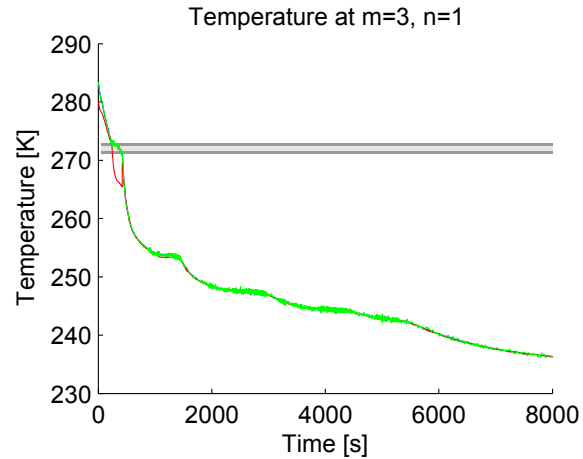

Applications – Optimal input

Optimal Control Problem minimizing cost-functional

1-dimensional, 25 states

fixed time horizon

Finding an optimal input such that constraints are satisfied

- State constraints (bounded)
- Input constraints (bounded, no large gradients – physically feasible)
- Terminal constraints (defining states at the end of time-horizon)

Applications – Optimal input

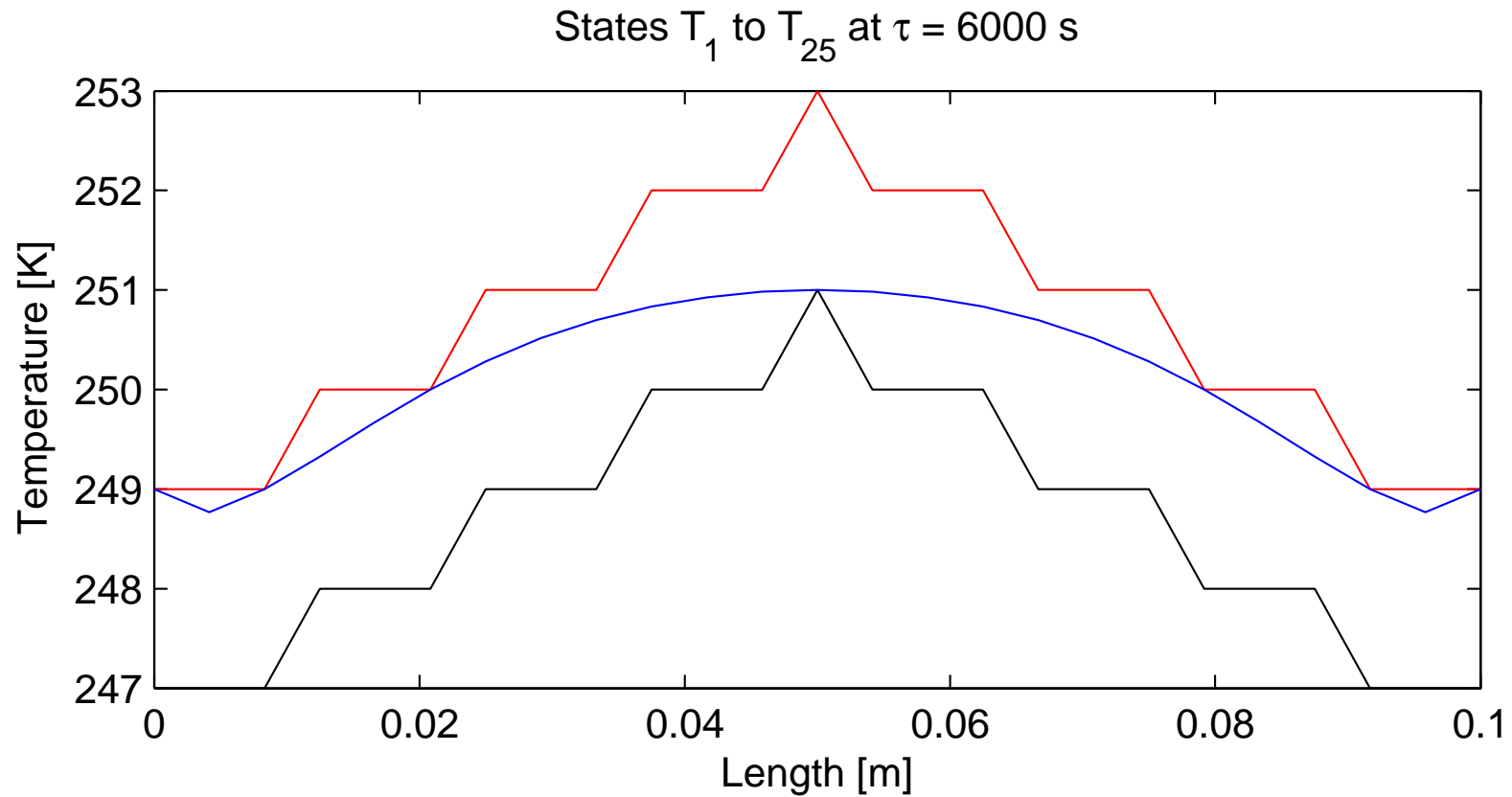

Applications – Optimal input

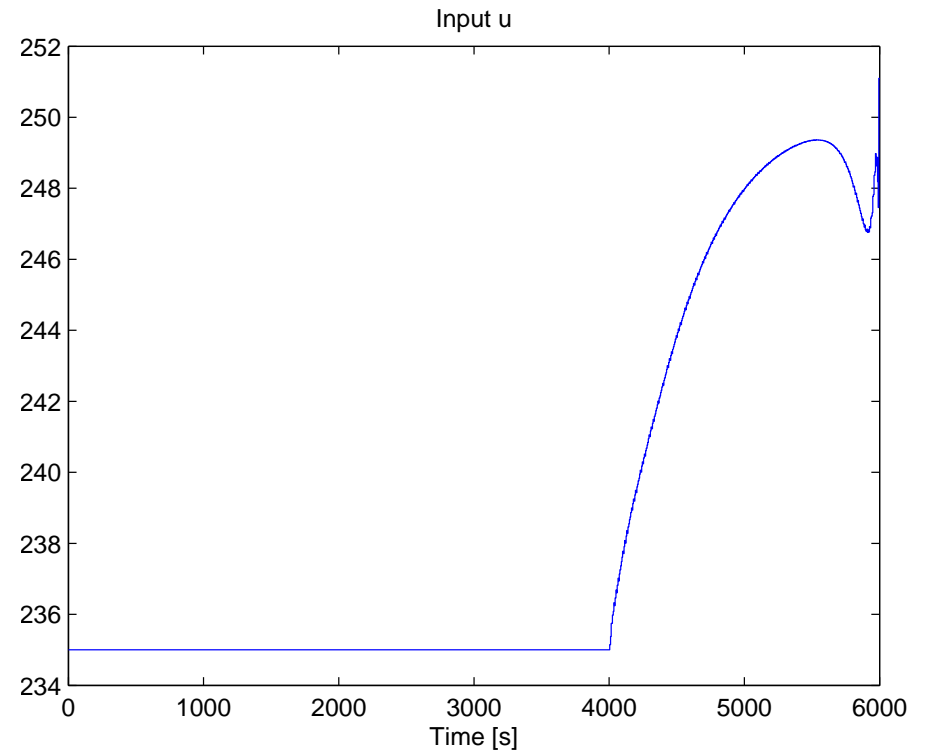
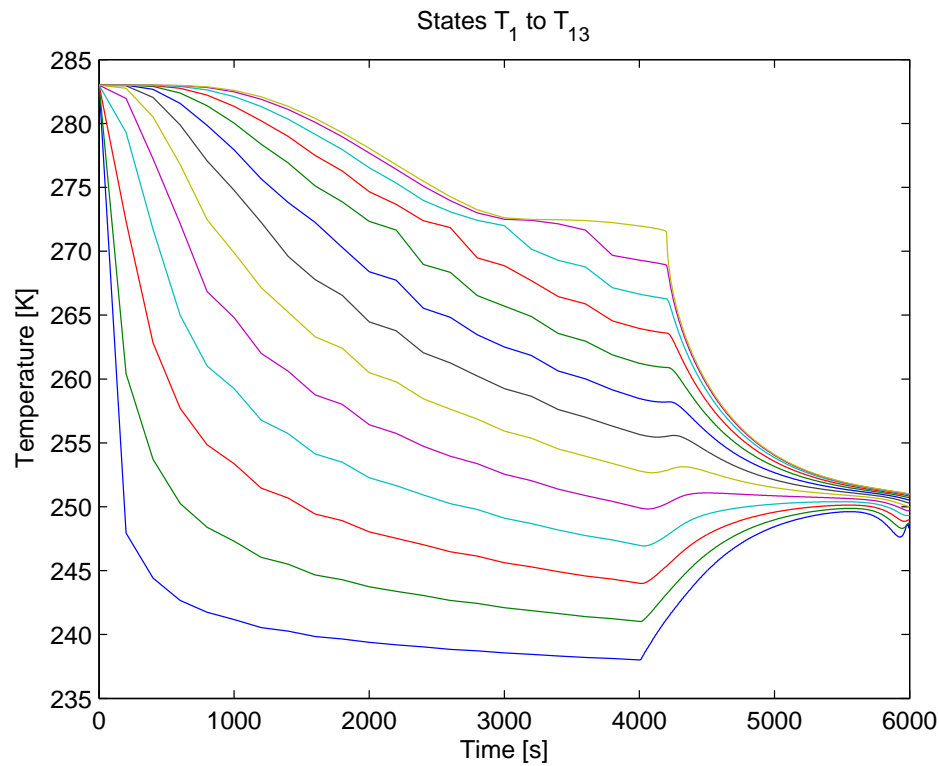

References

- Picture of vertical plate freezer from MMC Kulde AS
 - <http://www.mmc.no>
- Picture of freezing curve
 - http://en.wikipedia.org/wiki/Cooling_curve
- Picture of measured freezing curve
 - <http://www.fao.org/wairdocs/tan/x5992e/X5992e00.htm#Contents>

Thank you for your kind attention!