

Quality consequences of fish bleeding and methods in commercial fisheries

Leif Akse, Sjúrdur Jøensen, Karsten Heia and Heidi Nilsen

Background



- Increasing awareness of «quality» in Norwegian wildfish catch and processing. Variation in raw material quality affects the quality of the end products as well as profitability and industrial balance.
- Today, Norwegian processors of white fish fillets focus on supplying high quality, high price, fresh (chilled) products to the European market.
- Valuable products, like fresh loins from cod and haddock, require high quality raw material, without discoloration or gaping. In particular such products demand a raw material well drained of blood.
- Fewer crew combined with high capture efficiency onboard trawlers, limits the ability to bleed the fish in a proper way as it comes aboard. Can take hours before the last fish is bled and gutted.

Processing industries ranging quality flaws by severity – financial impact

survey from Norwegian fish processing industries
(# 4)

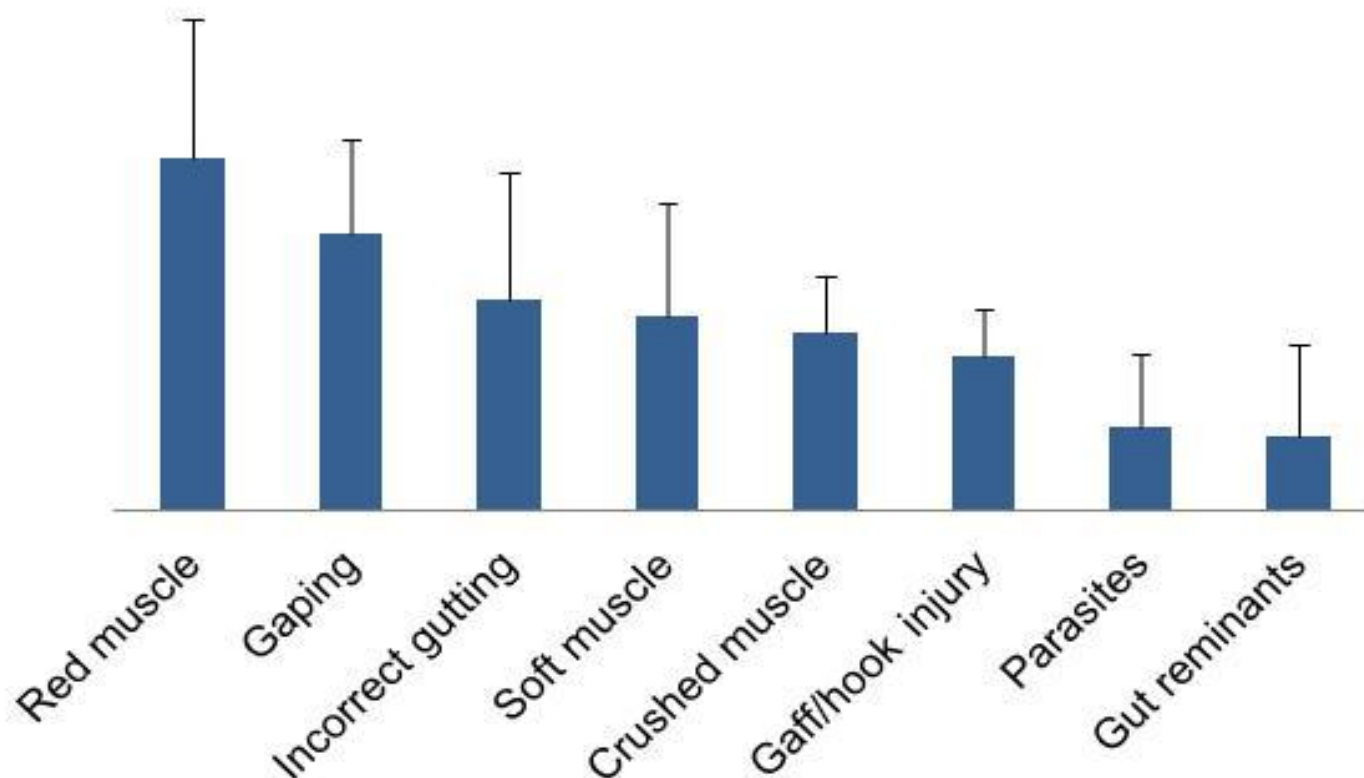

Quality consequences of fish bleeding

Objective of study

- Identify critical factors in catch and handling practices that will affect bleeding and bleeding quality in whitefish, as related to time and initial processing
- Increase knowledge on parameters influencing efficient bleeding

Exsanguination trial, cod

- Compare six different ways of slitting blood vessels/gills prior to bleeding
- Evaluate effect of time from catch until start of bleeding
- Sensory evaluation scheme, three attributes
 - Blood in vessels – bellies
 - Red color in bellies
 - Red color in loins and tailsEvaluation score, range 1 – 4, the lower the better
- Measuring blood in muscle – instrumental assessment
 - Diffuse reflectance spectroscopy («blood index»)



Sensory evaluation – score criteria

Blood-filled veins in the belly (evaluated prior to filleting)

- Score 1; No blood left in the veins
- Score 2; Up to three veins are partial blood-filled
- Score 3; Most of, or all the veins are partial blood-filled
- Score 4; All veins are completely blood-filled

Red colored belly flaps (evaluated on left fillet, skin on)

- Score 1; No red color (light and white muscle)
- Score 2; Pale red/pink color on parts of the belly flaps
- Score 3; Pale red color all over the belly flaps
- Score 4; Dark red color all over the belly flaps

Red colored loins and tails (evaluated on left fillet, skin on)

- Score 1; No red color (light, white muscle)
- Score 2; Pale red/pink color on parts of loins and tail
- Score 3; Pale red/pink color all over the loins and tail
- Score 4; Dark red color all over loins and tail



Instrumental assessment of color/discoloration

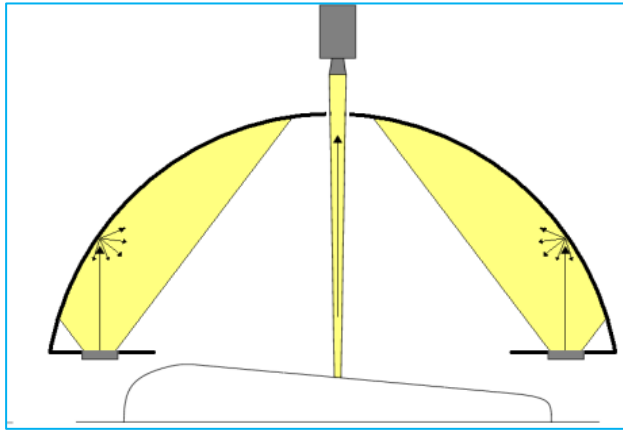

Diffuse reflectance

- hyperspectral imaging
- processing line measurements
- objective assessment

Colour – as measured by diffuse reflectance spectroscopy; bled and not bled samples

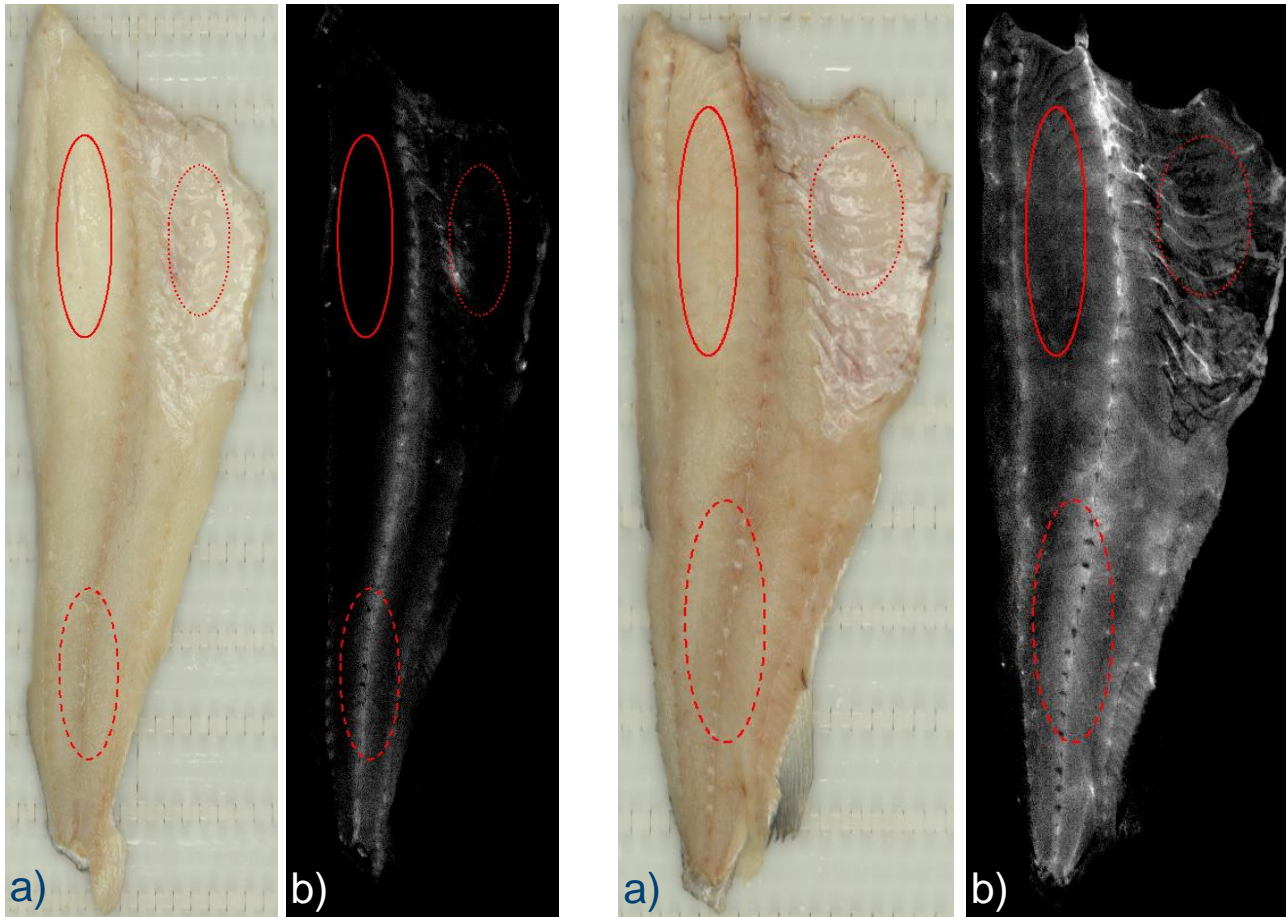

- a) Colour image
- b) «Blood index» image

Colour and
blood index
evaluated from
the circled
areas

Bled immediately after catch

Not bled after catch

Bleeding trial, cod

- Methods applied (exsanguination, gutting)
 - 1 slit method (cutting the artery from the heart to the gills)
 - 2 slit method (cutting the two arteries from the gills to the muscles)
 - throat cut (slitting the throat open, cutting all three arteries)
 - gill-cut method (all the gills arches on one side are cut)
 - evisceration – head on or head off (the fish is gutted and viscera removed without prior bleeding, exsanguination after gutting)
- Time from catch until start of bleeding
 - 0 min
 - 30 min
 - 60 min
 - 180 min
- Bleeding in circulating sea water, 30 min



Results

Comparing bleeding methods

Cod bled or eviscerated immediately after catch (0 min) as compared to not bled (20 hrs)

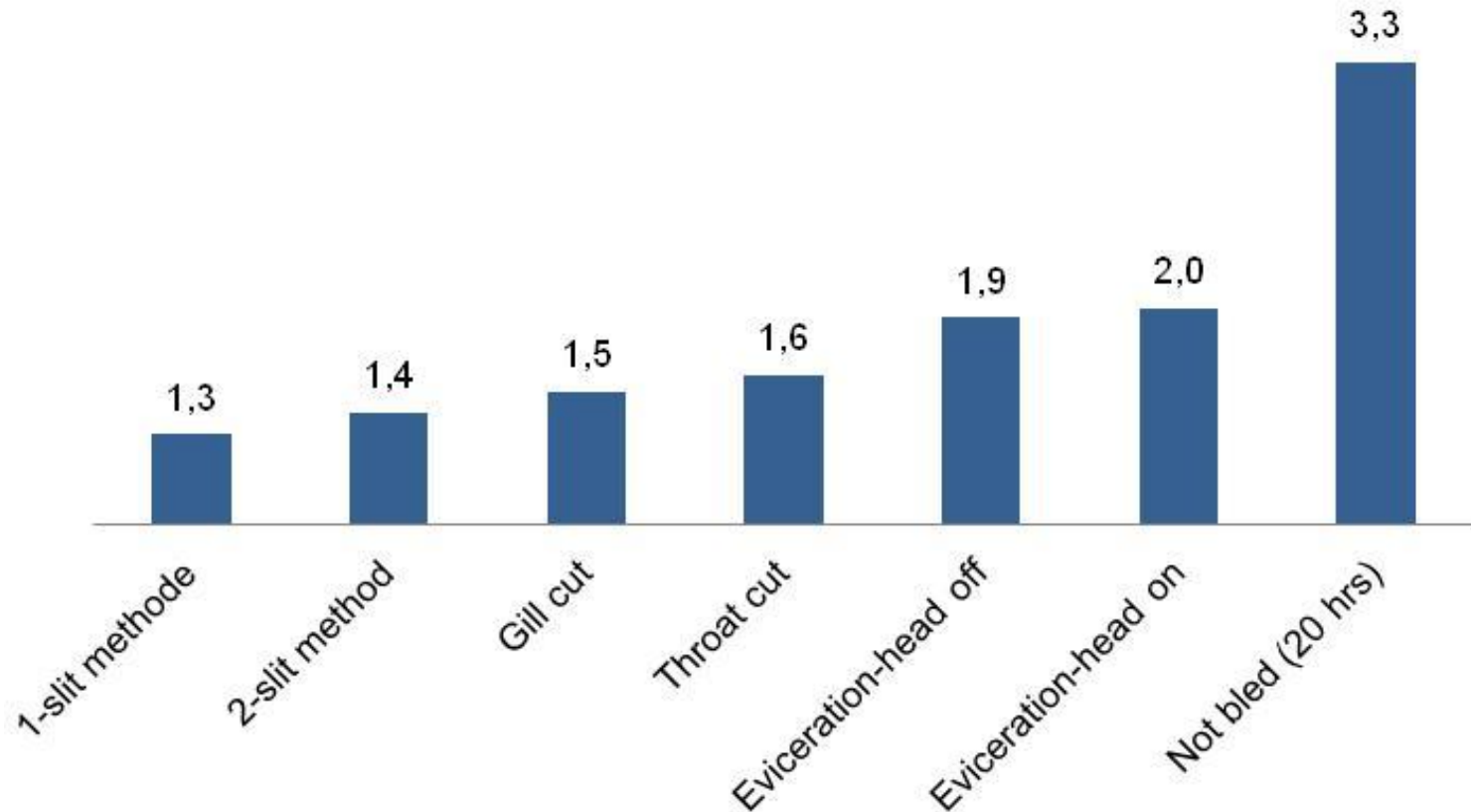

Two steps (bleeding + gutting) or evisceration

Bled or evisceration immediately after catch, sensory score

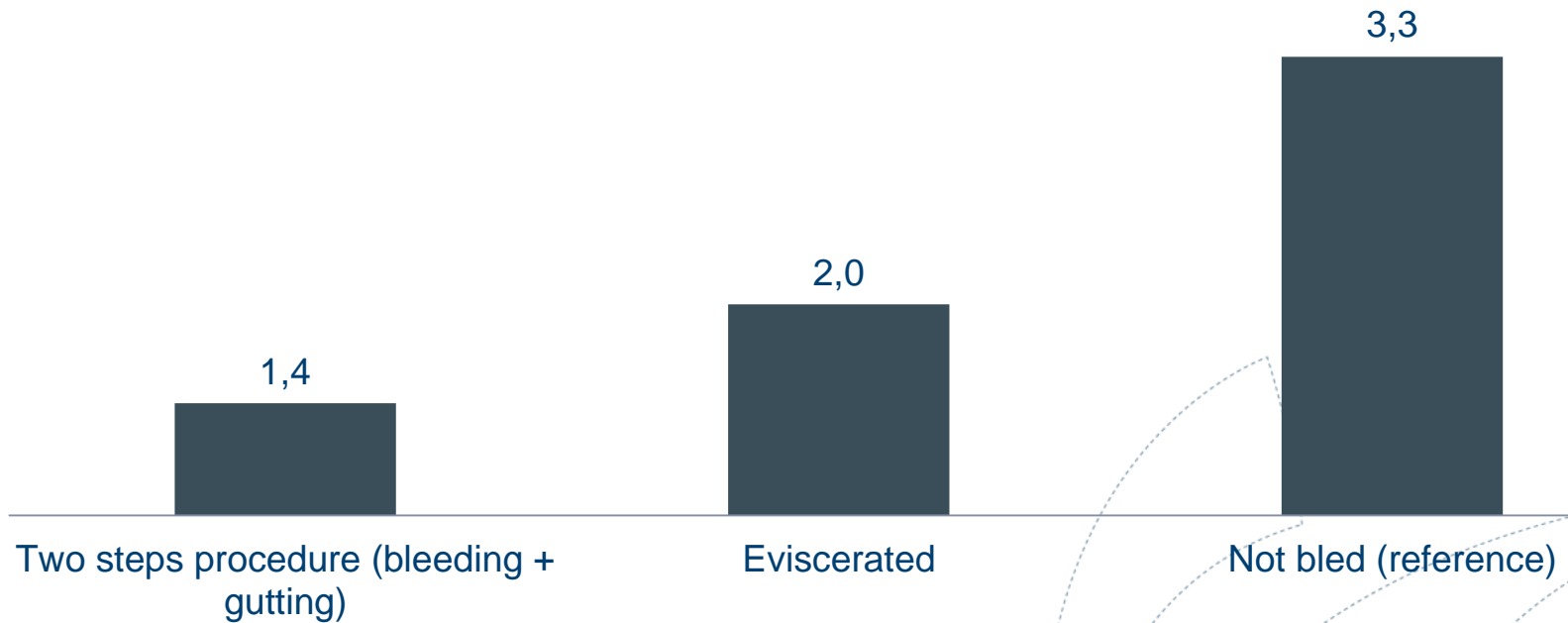

Blood-ratio measured in loins and belly, bled immediately after catch

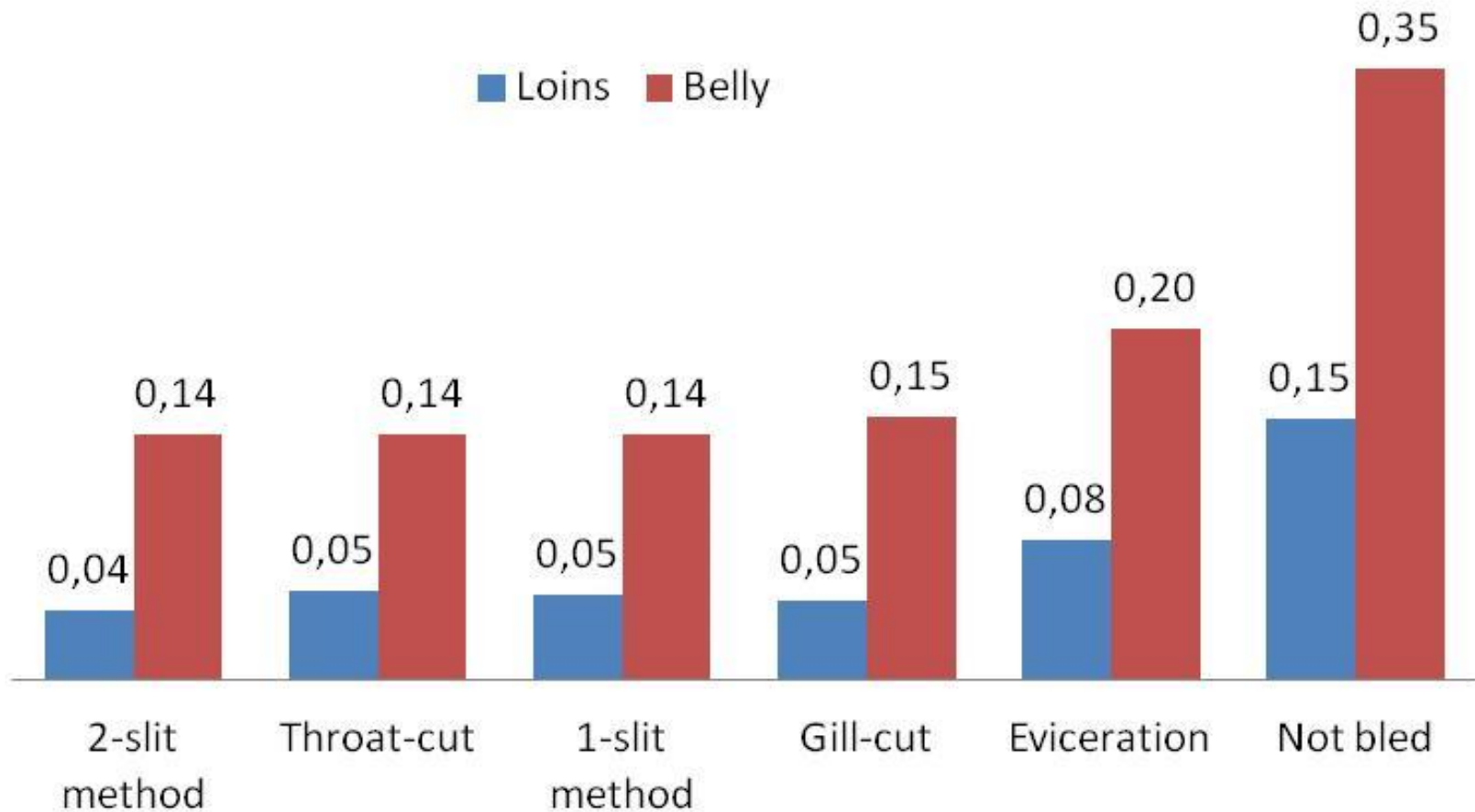

Bleeding - time after catch

Average score, all attributes, n=10

■ 0 min ■ 30 min ■ 60 min ■ 180 min ■ Not bled

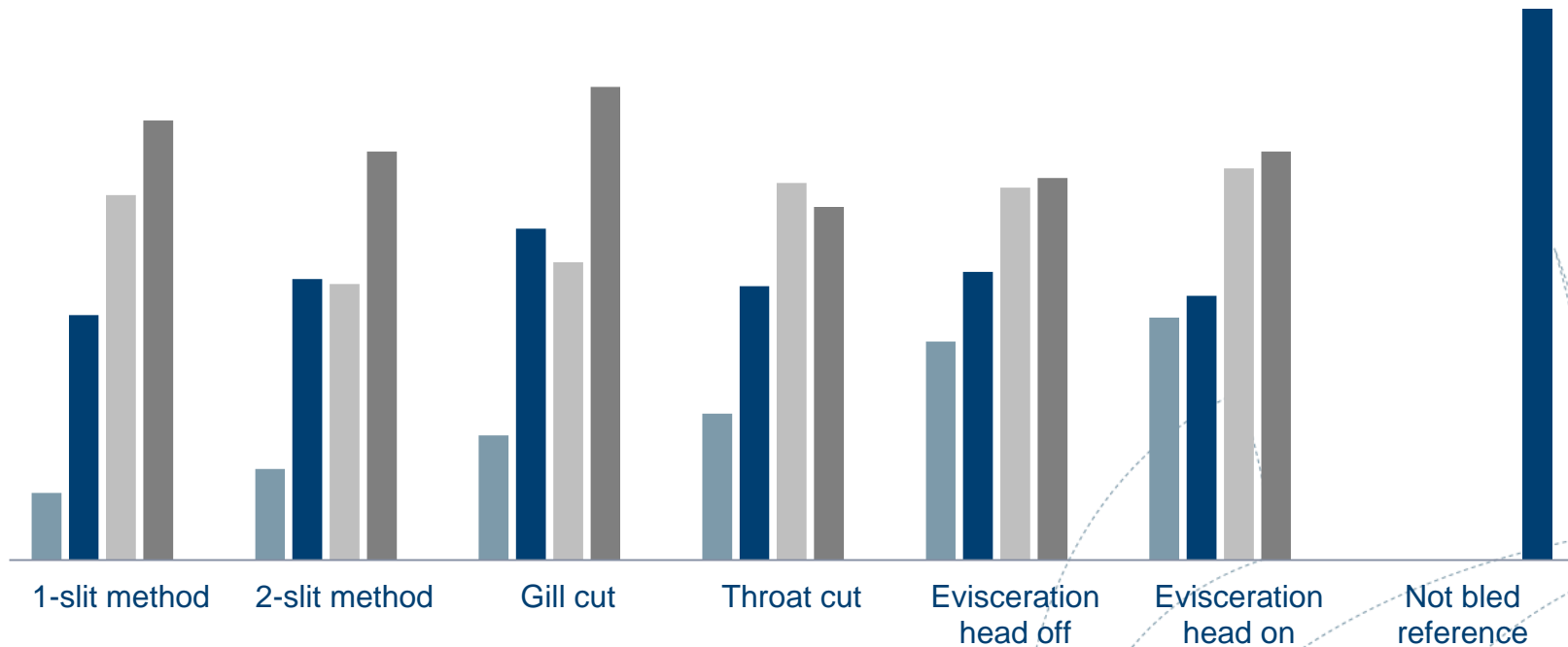

Time between catch and bleeding

Bled immediately after catch



Bled 3 hours after catch

Average of all methods and criteria (n=60)

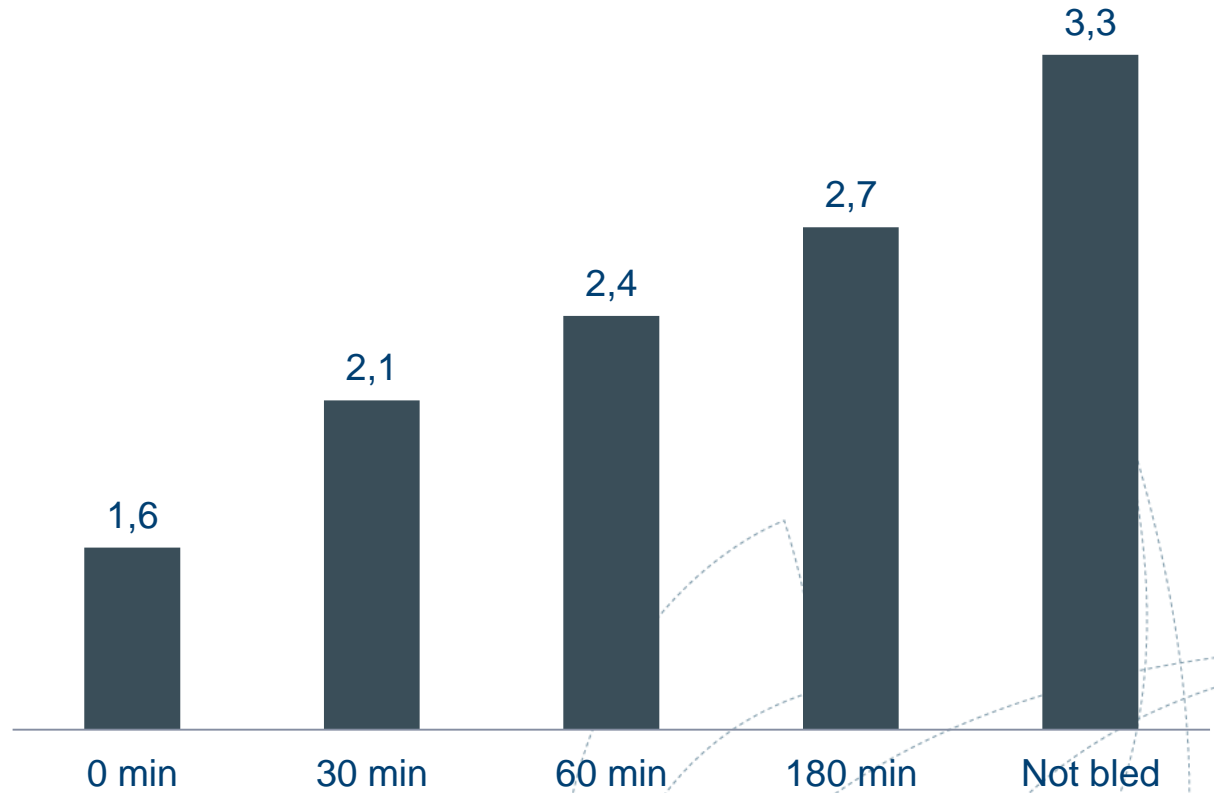

Blood-ratio in loins and belly of cod; bled 0, 30, 60 and 180 min after catch, average of all methods and criteria

Blood-ratio, average of all methods and criteria

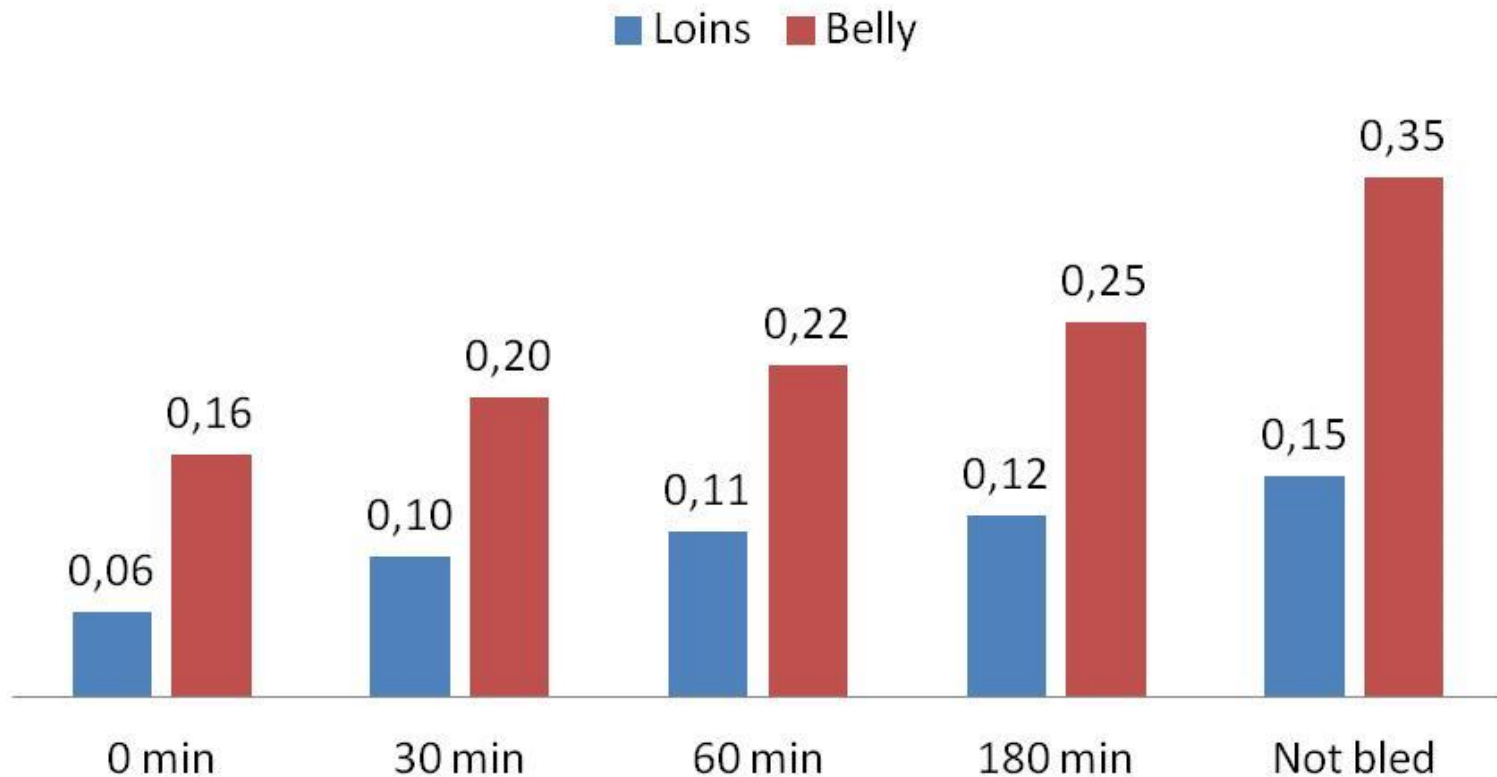

Conclusion

- Two steps methods, bleeding the fish before gutting, provided better exsanguination compared to evisceration and bleeding after gutting
- Only marginal differences between the various two steps methods
- The time from catch to start of bleeding is the single most important factor in order to obtain proper exsanguination
- Cod should be bled before 30 minutes after catch, when bled three hours after catch exsanguination was not much better than unbled fish
- Measuring color / blood by diffuse reflectance spectroscopy may be used as a tool for industrial grading of the raw material

Thank You



This project was financed by
The Norwegian Seafood Research Fund
and *Nofima*